

JBC

www.jbctools.com

INSTRUCTION MANUAL



AT420

Adjustable Thermal Tweezers

This manual corresponds to the following reference:

AT420-A

Packing list

The following items should be included:



Adjustable Thermal Tweezers1 unit

Screwdriver.....1unit
Ref. 0023074

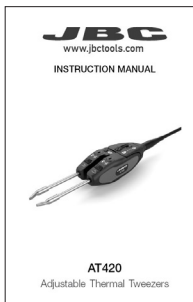

Manual1 unit
Ref. 0030510

Features

DI, DDE, DME*
Control Unit



ATS*
Stand for AT420
Adjustable Thermal Tweezers

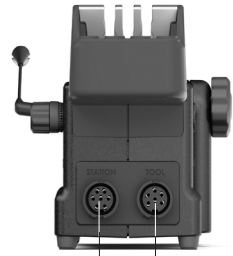

C420*
Cartridges



AT420
Adjustable Tweezers



**not included, sold separately*

Changing Cartridges

1. Unlocking

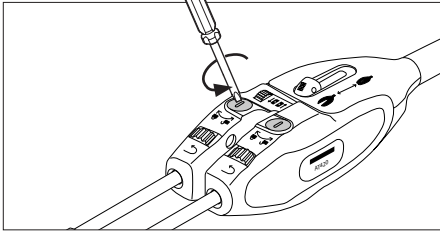

Unlock the fixing screws.

2. Removing

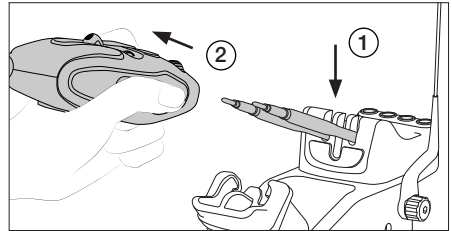

Place the cartridges in the extractor (1) and pull the tweezers to remove them (2).

3. Positioning

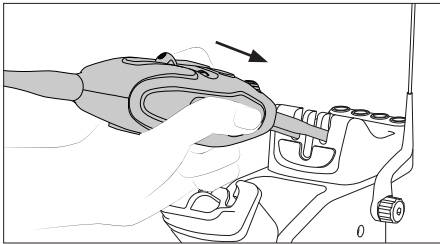

Use the vertical grooves to position the cartridges and place the tweezers onto the cartridges.

4. Inserting

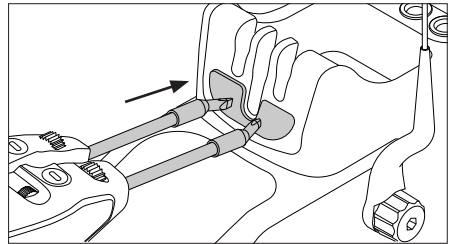

Press the cartridges against the extractor and make sure that the cartridge is inserted up to the mark*.

*Important

It is essential to insert the cartridges as far as the mark for a proper connection.



5. Rotational Cartridge Alignment and Locking

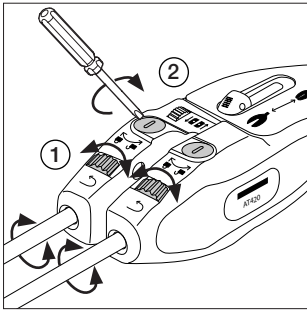

Slightly turn the wheels to align the cartridges as required (1). Then lock the cartridge fixing screws* (2).

6. Vertical Cartridge Alignment

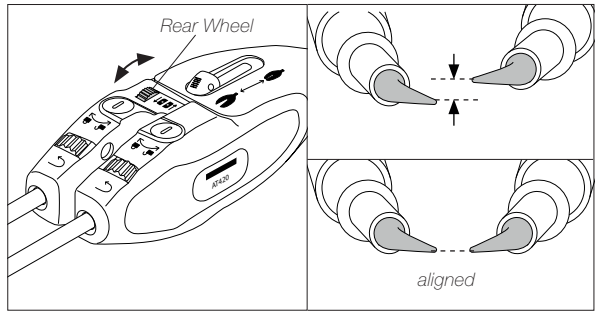

The wheel allows the tips to be adjusted so that they are aligned when the tweezers are closed.



Once the alignment has been made, it is imperative to fix the cartridges by tightening the fixin screws. It takes a single turn of the screw to lock it in place.

Tweezers Positioning

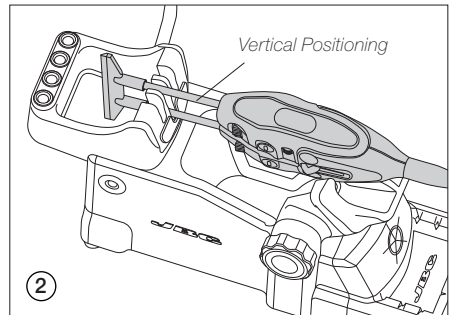

The tweezers position in the stand is shown in the image (1).

Note:

When using the customized cartridges like ref. C420283 and ref. C420286, place the tweezers vertically, as shown in the image (2).

Compatible Cartridges

Adjustable Thermal Tweezers **AT420** works with **C420** cartridges. Find the model that best suits your soldering needs at www.jbctools.com.



Blade



QFP



Chip
Components



Customized

Wiper

The integrated wiper offers different ways to clean the cartridge tips.

Tapping

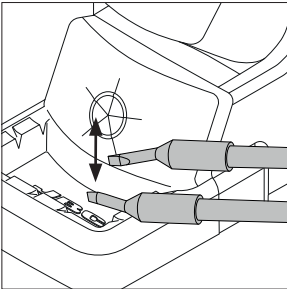

Tap gently to remove excess solder.

Wiping

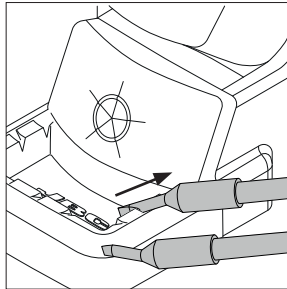

Use the slots to remove the remaining particles.

Sponge

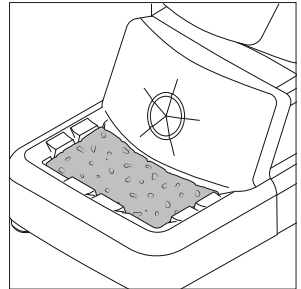

The softest cleaning method. Keep the sponge damp with distilled water when working to avoid tip wear.

Wiper and Brass Wool Replacement

The wiper and brass wool can easily be removed for cleaning or replacement when they are worn.

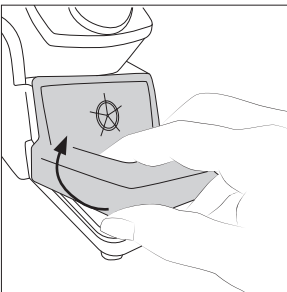

Lift the wiper at its front edge.

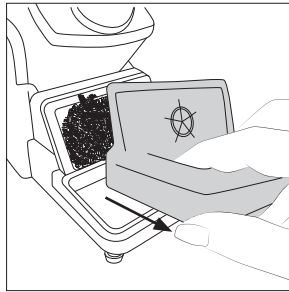

Remove the wiper by pulling it out.

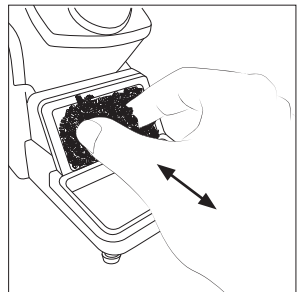

Replace the brass wool with a new one when it is worn out. Place the wiper back or replace it if desired.

Safety



It is imperative to follow safety guidelines to prevent electric shock, injury, fire or explosion.

- Do not use the device for any purpose other than soldering or rework. Incorrect use may cause a fire.
- The power cord must be plugged into approved bases. Be sure that it is properly grounded before use. When unplugging it, hold the plug, not the wire.
- Do not work on electrically live parts.
- The tool should be placed in the stand when not in use in order to activate the sleep mode. The soldering tip or nozzle, the metal part of the tool and the stand may still be hot even when the station is turned off. Handle with care, including when adjusting the stand position.
- Do not leave the appliance unattended when it is on.
- Do not cover the ventilation grills. Heat can cause inflammable products to ignite.
- Avoid flux coming into contact with skin or eyes to prevent irritation.
- Be careful with the fumes produced when soldering.
- Keep your workplace clean and tidy. Wear appropriate protection glasses and gloves when working to avoid personal harm.
- Utmost care must be taken with liquid tin waste which can cause burns.
- This can be used by children over the age of eight and also persons with reduced physical, sensory or mental capabilities or lack of experience provided that they have been given adequate supervision or instruction concerning the use of the appliance and understand the hazards involved. Children must not play with the appliance.
- Maintenance must not be carried out by children unless supervised.

Specifications

AT420

Adjustable Thermal Tweezers

Ref.: AT420-A

- | | |
|---|---|
| - Max. Power per Cartridge: | 80 W |
| - Cable Length: | 1.3 m / 51.2 in |
| - Total Net Weight: | 126 g / 0.278 lb |
| - Package Dimensions/Weight:
(L x W x H) | 277 x 73 x 50 mm / 194 g
10.91 x 2.87 x 1.97 in / 0.428 lb |

Complies with CE standard
ESD Safe

JBC

Warranty

JBC's 2 year warranty covers this equipment against all manufacturing defects, including the replacement of defective parts and labour.

Warranty does not cover product wear or misuse.

In order for the warranty to be valid, equipment must be returned, postage paid, to the dealer where it was purchased.

Get 1 extra year JBC warranty by registering here:

**<https://www.jbctools.com/productregistration/>
within 30 days of purchase.**



This product should not be thrown in the garbage.

In accordance with the European directive 2012/19/EU, electronic equipment at the end of its life must be collected and returned to an authorized recycling facility.



www.jbctools.com

0030510-221222